

Data Sheet



Article number: 203180M20200B1V

Description: E+G levelling foot
GN 31-80-M20-200-B1-V

Note: V Without nut, External hexagon at the top, Wrench flat at the bottom

Measures

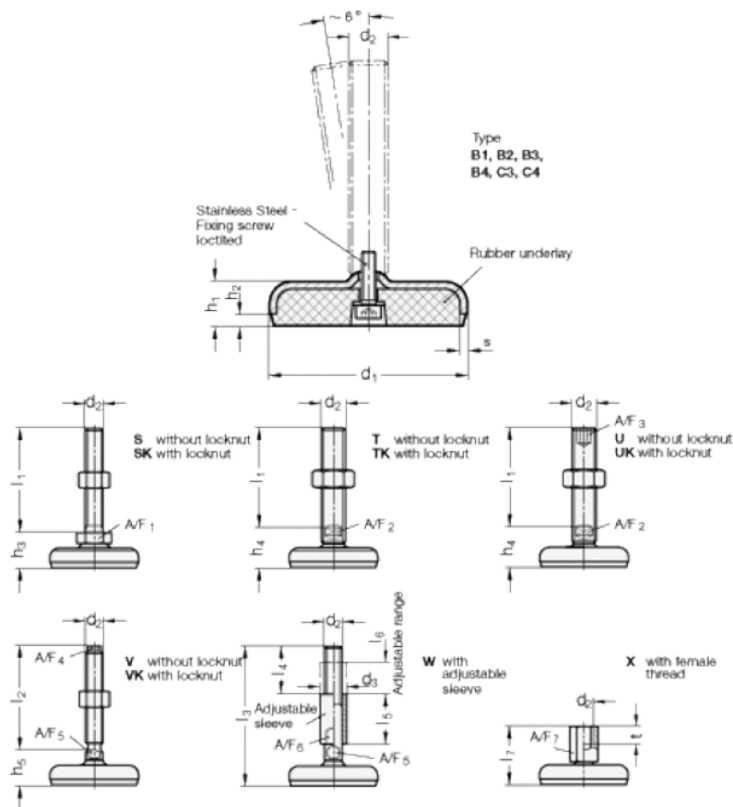

A/F4	= 13	s = 3
A/F5	= 16	
d1	= 80	
d2	= 20	
h1	= 18	
h2	= 5	
h5 +4.0/0	= 30	
l2	= 200	